

Reflections

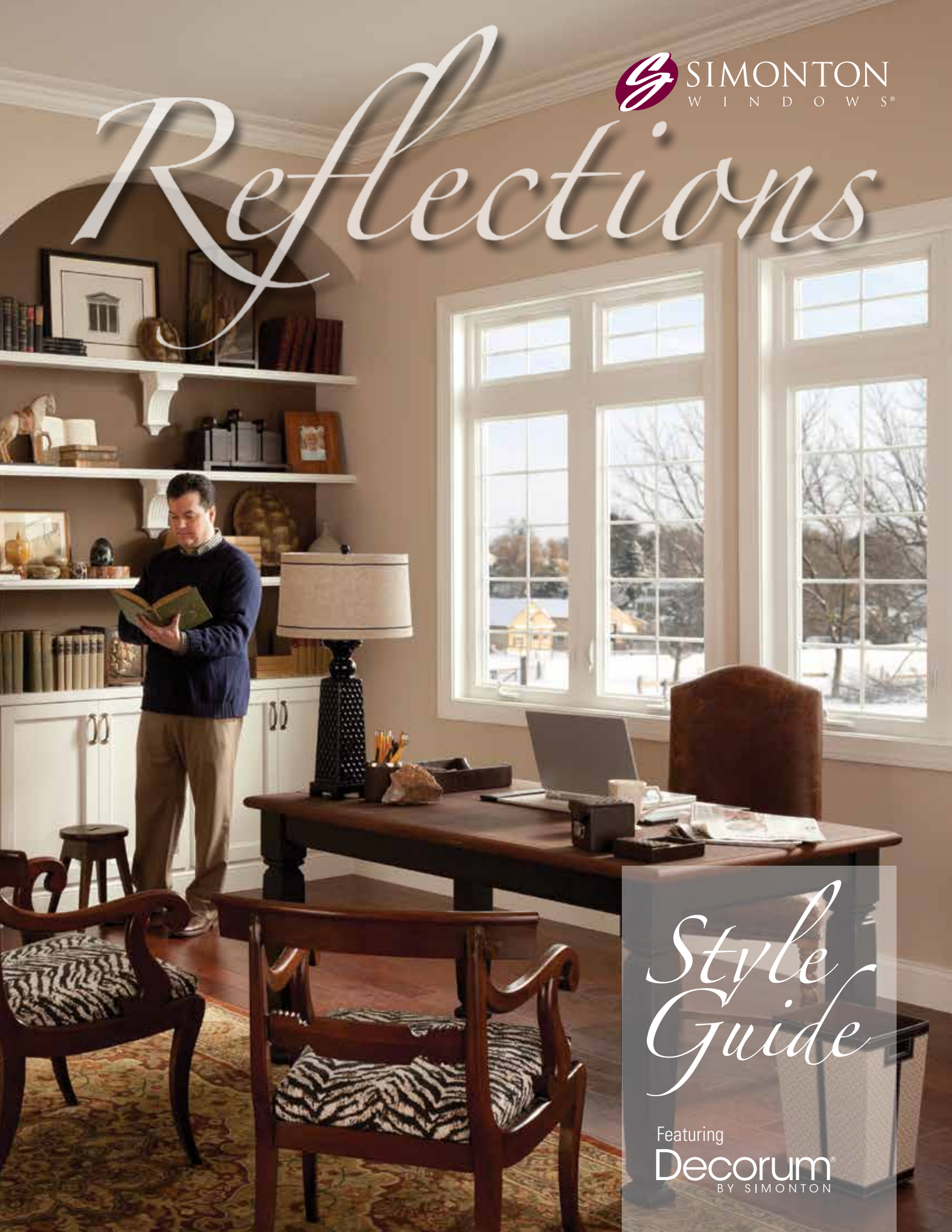

Style Guide

Featuring
Decorum®
BY SIMONTON

Reflections

With **Simonton** you're not only getting the ideal window for you and your home, you're also getting the peace of mind that comes from over **65 years of experience.**

1940

1946
Simonton family founds Penn Vent Awning Company

1980

Changed specialization to vinyl windows

1992

7-day delivery introduced

2007

Simonton voted #1 in quality by *Builder* magazine

2009

Decorum® style options launched

2010

Established ENERGY STAR® national zone-specific packages

2015



The Simonton Brand

We handcrafted our very first products in **1946** when gas was only 15 cents a gallon, the electric dryer was first sold and Dean Martin was just starting his career. Since then a lot has changed, including our products, but our standards for quality haven't budged.

Throughout the years, Simonton® has developed and perfected innovative, energy-efficient solutions that our customers have come to trust. Today, our legacy of customer loyalty and satisfaction is second to none.

Our **Reflections® 5500 premium vinyl replacement windows and doors** provide a wide variety of options to ensure that you can find the perfect custom styling solution for your home. With industry-leading energy efficiency, weather resistance and quality, they provide unsurpassed reliability over the long haul. And to top it off, each Reflections 5500 window is custom built specifically for your home, delivered quickly and backed by our **Double-Lifetime Limited Warranty.**

 **SIMONTON**
Reflections®



Our goal is to make the process of selecting the ideal window easy. The possibilities are endless, and that's why we're here to help you cut through the clutter with **four easy steps**.

1 Choose Your **Operating** Style:

A wide variety of window and door styles provide functional options that are both pretty and smart.

2 Choose Your **Unique Configuration**:

A wide variety of window and door styles provide functional options that are both pretty and smart.

3 Choose Your **Style** Options: **Decorum** BY SIMONTON

Choose from a portfolio of popular exterior colors, interior colors, rich woodgrain laminates and custom hardware finishes, to create a custom style that fits your décor.

4 Choose Your **Glass and Grid** Options:

A variety of grid styles and patterns allow you to highlight the architectural style of your home. And choose from a selection of specialty glass options that help provide maximum energy efficiency, increase privacy, security and sound reduction.

1 Choose your operating style.

With Simonton Reflections® 5500 you can choose from a variety of window shapes and operating styles to complement any room in your home. Whether you want a classic Double Hung or something more modern, Reflections 5500 is the right choice for you.

Lauren's Style

After ten years in her home, Lauren is finally giving it a well-deserved update. She plans to make her ultimate dream kitchen a reality by adding Awning windows above her counter, a Bay window to overlook her back yard and a new Patio Door to let in more light. She also wants to replace the windows in her living room with vinyl, but is worried that they will not match the windows throughout the rest of her house.

With a wide variety of operating styles from Reflections 5500, she can select Double Hung windows that will operate in the same way as her old windows and get a new Bay window, Awning windows and Patio Door that will coordinate perfectly to really bring her living room and kitchen together.



Myth - If I replace my house's old windows, I have to replace them all at once.

In fact, many customers choose to replace their windows in stages. And with Simonton's wide variety of window types and color options, you can select a window that will match your home's existing style.

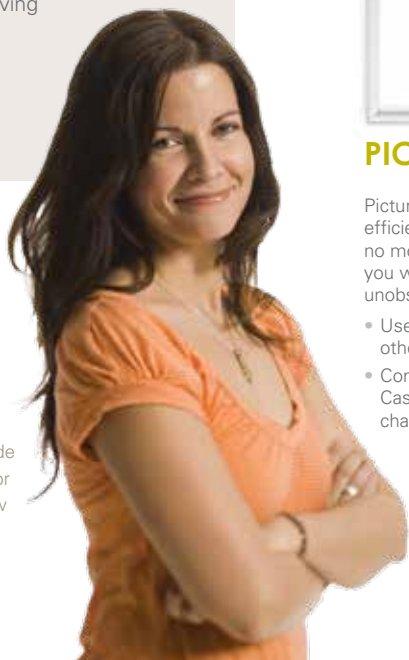

PICTURE

Picture windows are the most energy-efficient style available and are fixed – with no movable sash. Choose this style when you want to illuminate a room or provide an unobstructed view.

- Use alone or in conjunction with other styles
- Combine with a Double Hung or Casement for ventilation while adding character to your home



AWNING

A top-hinged window, also called an Awning, swings outward for ventilation. Create a striking look by using multiple Awnings in both vertical and horizontal mulled configurations.

- Create a contemporary wall of light with a multi-unit Awning design
- Streamlined crank handle easily opens and closes Awning windows
- Corrosion-resistant* hardware provides a lifetime of smooth operation.

*Corrosion-resistant refers to use in normal weather conditions without excess salt and debris in the atmosphere. Corrosion of rollers may occur in coastal applications or in areas with extreme fluctuations in weather patterns.

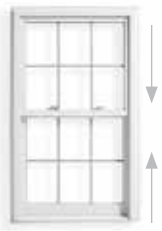

DOUBLE HUNG

For a timeless look, choose the Double Hung, which is popular in Victorian, Craftsman and Colonial architecture. Both sash on Double Hung windows slide up and down vertically.

- The exclusive Simonton Sill® is triple-stepped and sloped to move water quickly away from your home and to help prevent air infiltration
- Tilt-in/lift-out sash makes cleaning easy from the inside
- The easy-glide sash and balance system allow the sash to raise and lower with ease
- Simonton's innovative Lap-Lok® meeting rail helps provide a tight seal for protection against the elements and increased energy efficiency
- Unique Denny Clip™ pivot system keeps sash in perfect alignment for easy operation



GEOMETRIC

Customize the look of your home with a stunning Geometric window. The dramatic options provide a contemporary look that will enhance any home.

- Select from a variety of optional grid patterns to create a unique look
- Available styles in Half-round, Quarter-round, Eyebrow, Circle, Octagon, Trapezoid, Pentagon and Hexagon



SLIDER

Slider windows glide horizontally from side to side. Available in a 2- or 3-lite configuration, 3-lite Sliders have operable end vents. They are perfect for replacing large Picture windows to gain ventilation.

- Corrosion-resistant* rollers and roller track provide a lifetime of easy operation
- Interlocking meeting stiles create a tight seal against the elements
- Lift-out sash can be removed for easy cleaning and maintenance

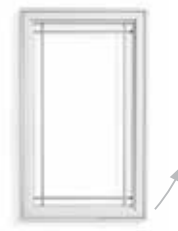

CASEMENT

The Casement features a hinged sash that opens outward. If you are looking for optimum ventilation and a wide-open view, the Casement is the perfect choice. Casements are the second most energy-efficient style available for your home.

- Casements crank outward for maximum ventilation and easy cleaning
- Optional folding crank handle allows for easy and convenient operation
- Advanced locking system secures sash at multiple points with one, easy-to-use handle



GARDEN

A Garden Window can bring a little bit of the outdoors in year-round.

- Two side windows can be opened or closed with the simple turn of a crank
- Seat boards are available in white pine laminate or wood veneer in either oak or birch and can be painted or stained
- Top-sloping insulating glass unit tempered for breakage resistance
- Sill cover resists water penetration
- Multi-point, single-lever locking system for added security
- Corrosion-resistant* hardware provides a lifetime of smooth operation.



BOW

A Bow window features windows mullied at 10-degree angles, which creates a rounded, more circular appearance than a bay.

- Bow windows feature 3-, 4- or 5-unit designs
- Equal-sized Double Hung or Casement windows can be used to create a Bow window with excellent ventilation
- Ideal for large window openings
- Head and seat boards in oak or birch veneer can be painted or stained to match the interior of your home
- Insulated seat boards provide increased thermal efficiency



BAY

Open up your home and bring the outside in with the addition of a Bay window. The dramatic look of a Bay creates a special nook and adds dimension to any room.

- Bay windows feature either Double Hung or Casement windows on each side of a center Picture window
- Available in either 30- or 45-degree angles
- Ideal for larger openings
- Head and seat boards in oak or birch veneer can be painted or stained to match the interior of your home
- Insulated seat boards provide increased thermal efficiency



PATIO DOOR

Redefine your living space with a Reflections 5500 Patio Door. Large glass areas open up a room while allowing easy access to the outside.

- Fusion-welded panel provides strength and thermal efficiency
- Double-strength tempered glass for increased safety
- Corrosion-resistant* rollers allow door to open and close smoothly
- Color-coordinated handle options to match your style
- Exterior keyed lock for maximum security
- Foot bolt for partial ventilation
- Sidelites and transoms available for added light and character

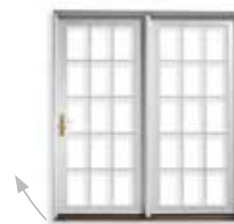

GARDEN DOOR

With a Garden Door you can create an elegant entryway for your home and achieve a greater sense of security.

- Continuous, fixed-gear hinge eliminates panel sag and increases weatherability
- Thick, high-performance weatherstripping
- 7/8-inch tempered insulating glass unit for greater thermal efficiency
- Available in center-hinge and French-hinge styles that swing in or out
- Solid brass handle with center bolt and keyed lock for increased safety
- Available with a white or tan interior and exterior

2 Consider a unique configuration.

The possibilities are virtually unlimited when you combine Reflections® 5500 windows and doors. Mulled configurations can create a beautiful wall of windows or a unique arrangement that will set your home apart.



Large Picture windows with transoms above add to the contemporary style of the room.



Myth – Adding a large window configuration to my home will allow in more of the sun's damaging ultraviolet rays that can fade my photos, furniture and carpet.

UV damage is something that can occur, but standard ProSolar® Low E glass on Reflections 5500 windows and doors blocks a large portion of UV rays from coming into your home. For greater protection, advanced glass like ProSolar Shade can block up to 95% and KeepSafe® laminated glass can block up to 99% of UV rays from entering your home and damaging your belongings.



A "doghouse" Geometric and Picture configuration accents the ceiling pitch and allows natural light into flood the kitchen.

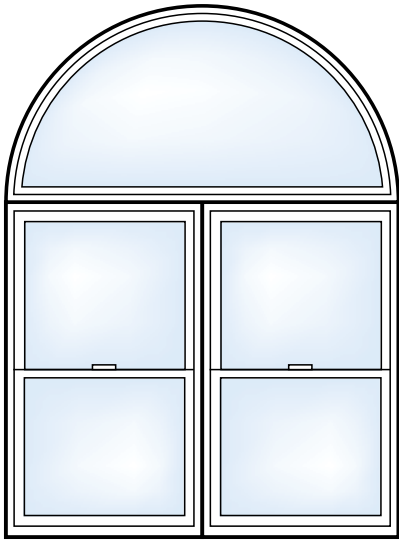

Two Double Hung windows mulled together with a Half-round Geometric window above.

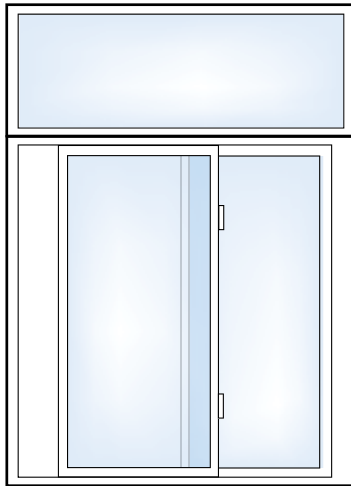

A 2-lite Slider topped with a Picture Window.

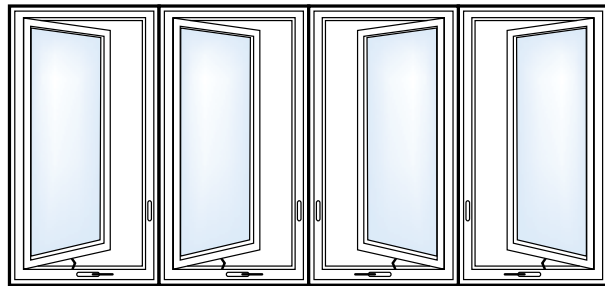

A wall of Casement windows.

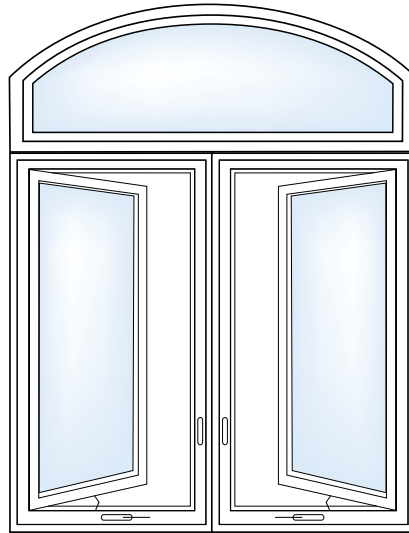

Two Casement windows with an Eyebrow with extended legs above.

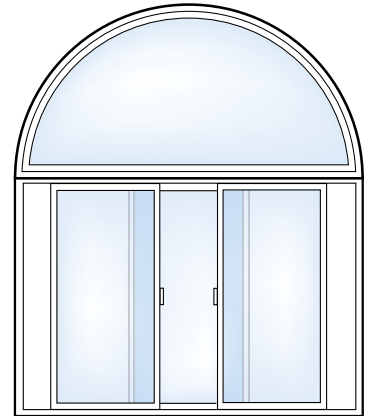

Half-round over a 3-lite Slider



A Picture window mulled with two Double Hung windows.

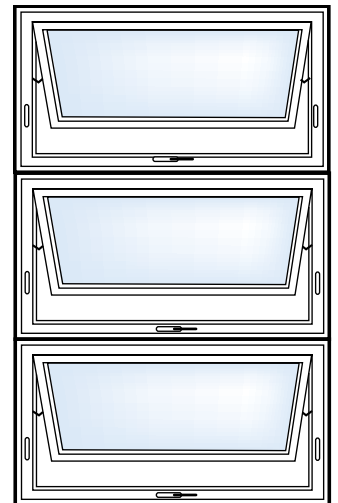

Three stacked Awning windows.

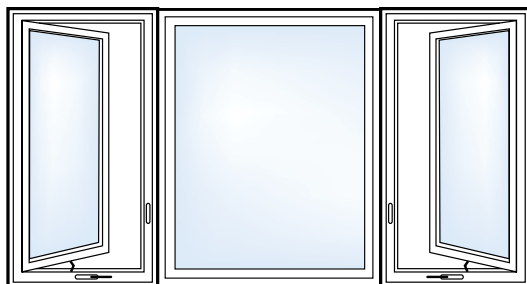

A Picture Window flanked by two Casements.

3 Choose your style options.

With Simonton,[®] finding the perfect match just got a lot easier. Every Simonton Reflections[®] 5500 window can be ordered with Decorum,[®] a portfolio of popular exterior and interior colors, rich authentic interior woodgrain laminates and popular hardware options designed to match metal finishes unique to your home.



Myth - If I replace my old windows with vinyl instead of wood, they won't match my cabinets or trim.

Actually, Simonton offers warm, realistic woodgrain interiors, including Antique Cherry, Maple or Contemporary Oak to match your cabinets and the other wood within your house perfectly. In fact, many people find it hard to tell that it's actually vinyl.



Mark & Karen's Style

Mark and Karen have been gradually updating their home over the last couple years and the next step is to replace their old windows. They prefer vinyl because they want to increase their home's energy efficiency, but they would also like the new windows to match their home's cabinetry, hardware and faucetry.

With Reflections 5500 windows and Decorum, Mark and Karen can choose an exterior color to match the outside of their home and our Antique Cherry woodgrain interior to match their cabinetry. They can also select Brushed Nickel locks to coordinate with their cabinets and their new Moen[®] faucet.

Whether you want to match your home's current style or change it entirely, the right style selections can go a long way. Choose from the options below to design your ideal window or door.

Exterior and Interior Colors – Standard

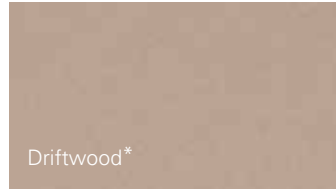
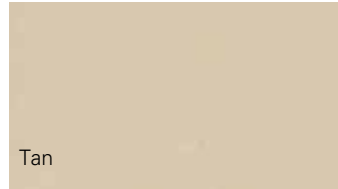
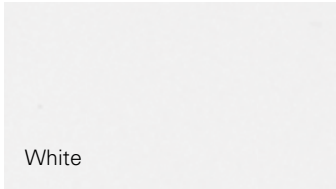

Exterior Colors – Custom

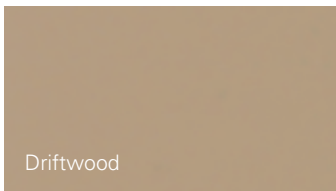
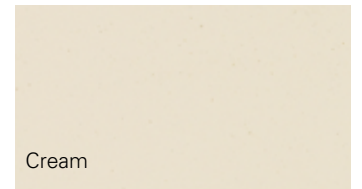
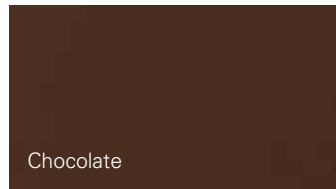
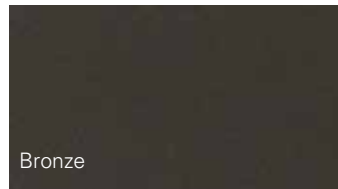
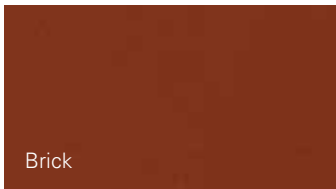

Interior Woodgrains – Custom

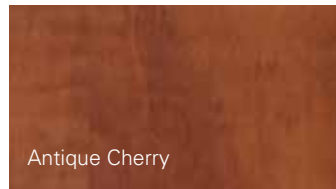
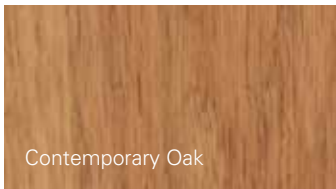

Hardware Finishes – Standard



Hardware Finishes – Premium

*Exterior colors are not available with a Driftwood interior
Decorum options are not available on Garden Door or Garden Window

4 Choose your glass and grids.

The right glass and grid style can transform the look of your home and accentuate its unique architectural style. With Simonton Reflections® 5500 you can choose from numerous decorative and specialty glass options, as well as a wide variety of grid patterns and styles.



Myth – I love how my old windows look and if I replace them with vinyl my house won't have as much character.

The days of the stereotypical white, vinyl window are long gone. Simonton vinyl windows have been approved and installed on numerous historical renovation projects with beautiful results. Our wide variety of glass and grid options can help you create a look that is as classic, modern, traditional or untraditional as you want.

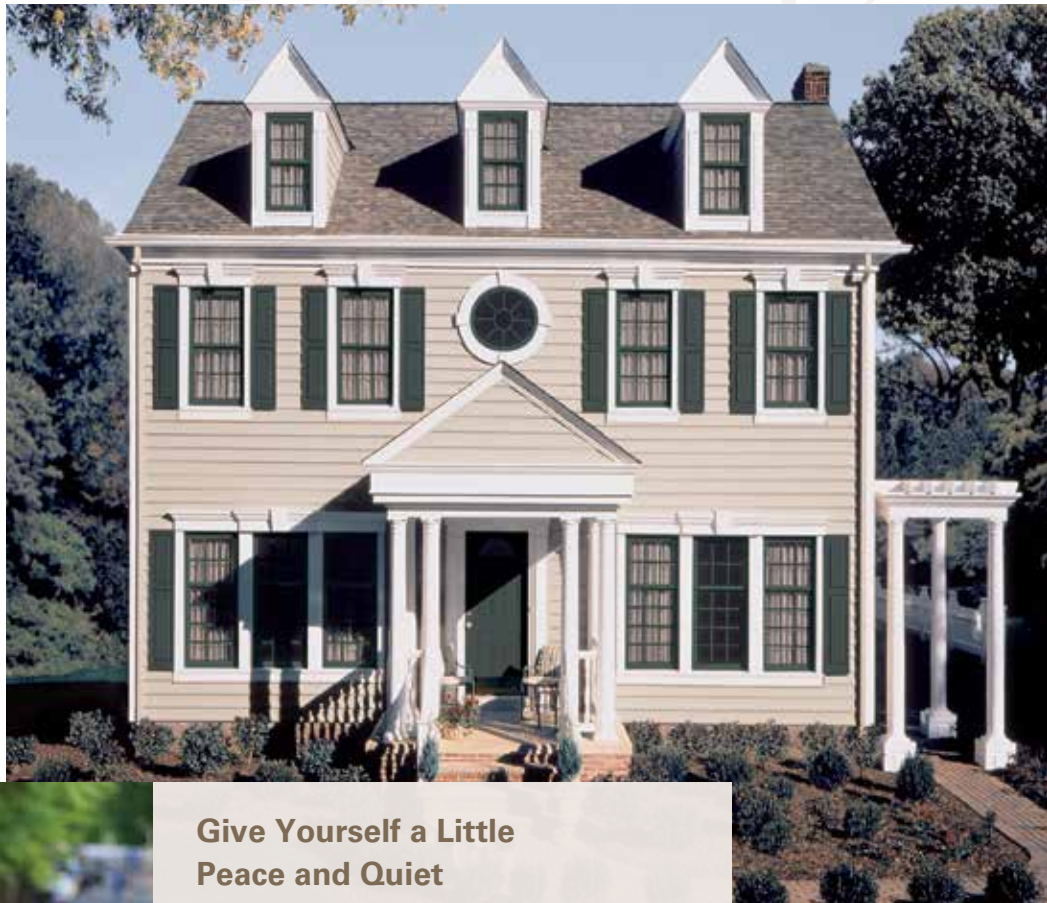

Give Yourself a Little Peace and Quiet

Do you live in a noisy area or next to a busy street? You might want to consider our laminated glass, which is designed to reduce unwanted noise infiltration. Even if you have just one bedroom or an office that you'd like to be a little quieter, a window with our laminated glass will make a dramatic difference and look just like the rest of our standard glass windows.



From traditional to more contemporary, the perfect combination of grid patterns, grid styles and glass options can help you create the look you want.

Grid **Patterns:**

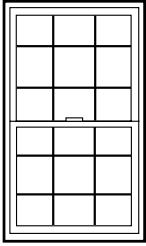

Colonial

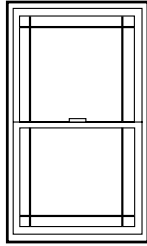

Perimeter

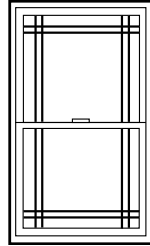

Double Perimeter

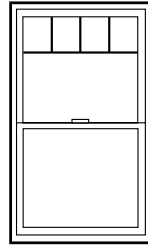

Victorian*

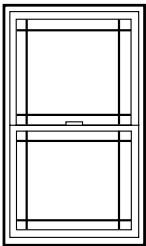

Prairie

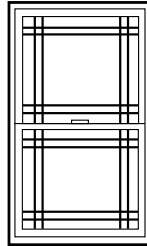

Double Prairie

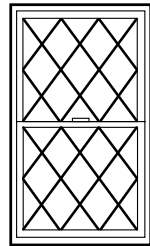

Diamond*



*Victorian and Diamond grid patterns are only available in flat grids

Between-the-glass **Grid Styles:**



Flat White



Flat Tan



Flat Driftwood



Sculptured Brass



Sculptured Antique Cherry



Sculptured White



Sculptured Tan



Sculptured Driftwood



Sculptured Maple



Sculptured Contemporary Oak

Glass Options:



Laminated
Safety, Sound, Security
& UV Fade Protection



Tempered
Safety



Bronze Tint
Energy Efficiency



Grey Tint
Energy Efficiency



Obscure
Privacy



ProSolar® Shade
High Efficiency, Solar Heat
Gain Control & UV Protection

Energy efficiency that's both comforting and comfortable.

Each of our Simonton Reflections® 5500 windows is designed with energy savings in mind. By choosing Reflections 5500 you're not only helping to reduce your heating and cooling costs; you're also keeping the outdoors in its place year-round.

Amy's Style

After eight years in her home, Amy is fed up with outrageous energy bills and has finally decided to replace her old aluminum windows. She knows vinyl windows are the most popular choice among builders today, that they will help her cut energy costs and that they will hold up well against Mother Nature.

With Reflections 5500 windows Amy can enjoy greater comfort and peace of mind during the hottest and coldest parts of the year. And thanks to our advanced thermal features, she can expect a great return on her investment.



Myth – Any type of replacement windows will increase the energy efficiency of an older house; it doesn't matter what material they are made out of.

Although energy-saving technology has come a long way over the last 10 years, not everyone has taken advantage of it. When it comes to energy efficiency, premium vinyl is hard to beat because it is one of the least conductive materials available.

Quality Insulation

Do you worry about condensation in your windows during the colder months of the year? Simonton Reflections 5500 windows help reduce temperature conduction and the potential for condensation. Our sealed, insulating glass units are set $\frac{3}{4}$ inch into the sash, providing extra insulation to keep the glass warmer.



Reflections 5500 comes standard with features that help **keep unwanted weather out:**

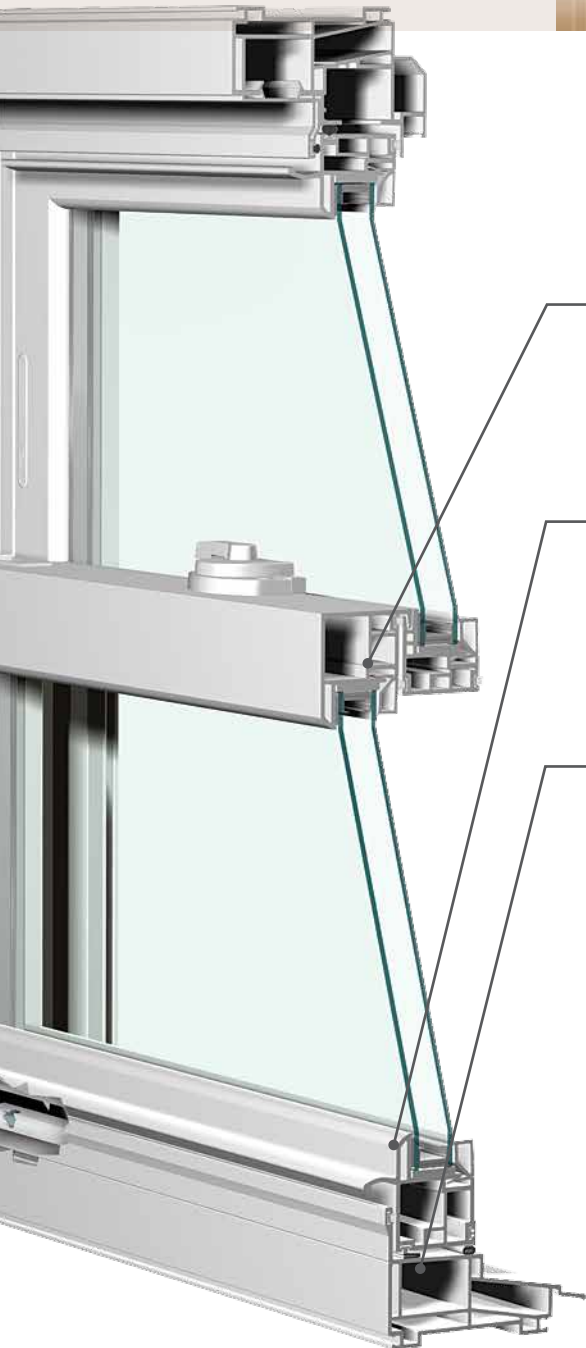

Our innovative **Lap-Lok® meeting rail** overlaps and interlocks the sash to create a tight seal that virtually eliminates air and water infiltration



The **Intercept® spacer system's unique U-shaped design** keeps glass warmer for increased efficiency and comfort, while flexing and contracting to reduce seal failure



Our exclusive **triple-stepped, sloped Simonton Sill®** forces water away from the window more quickly than flat, conventional sills to help protect your home from water infiltration, even in heavy rain



ProSolar® Low E glass with Argon gas reduces temperature transfer to help lower energy costs and keep your home comfortable all year long. It also helps block ultraviolet rays that can fade carpet, photos and furniture.



Can be ordered to meet **ENERGY STAR®** guidelines for any region of the country, no matter where you live

Our standards are just as high as yours.

Every Simonton Reflections® 5500 window and door is manufactured under our stringent quality-control system. They're also backed by 65 years of engineering and innovation to ensure that the products you put in your home are durable and hassle-free.



Myth – All window materials are about the same.

We recommend inspecting your windows once a year. However, vinyl windows require much less maintenance over time than wood windows. Unlike wood, vinyl won't rot, peel or flake. And they don't require scraping or painting. In fact, premium vinyl windows maintain their original beauty and require virtually no maintenance over time.



Karl & Janet's Style

Karl and Janet have lived in their home for 20 years and are planning to replace their old wood windows with vinyl. After scraping and painting wood windows for the past 20 years, Janet is looking for a solution that requires the lowest amount of maintenance possible. Karl loves what he's heard about vinyl, but wants to make sure that they make a quality investment in their home. Having recently retired, they both want to be able to travel or go on vacation and not worry about protecting their home from the elements.

With Reflections 5500, they can both have exactly what they want. Simonton vinyl windows are extremely low maintenance. And our industry-leading quality will give Karl and Janet the peace of mind they're looking for, while at home or abroad.



Reflections 5500 makes taking care of windows **simple**:

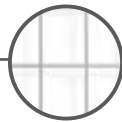

Grids located between the two pieces of glass eliminate the need to dust or clean window grids



Operable sash that tilt and lift out allow you to clean both sides of the window quickly and easily, from inside your home



Reflections 5500 windows and doors **remain low maintenance** over time because they don't require regular painting and do not rot, flake, peel or chip like wood windows.

When it comes to Simonton,[®] the **quality** is in the details:

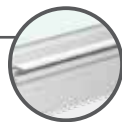

A **contoured lift rail** is actually molded into the sash to provide lifetime durability



A **stainless steel constant force coil spring balance system**, allows you to easily move the window sash to any desired position, even after years of use



Our unique **Denny Clip™ pivot system** helps to maintain perfect sash alignment on Double Hung windows



Fusion-welded construction bonds each corner together to create a rigid, one-piece frame that offers reliable strength and durability



Every window that Simonton builds is **AAMA Gold certified**, which means that it has passed stringent tests for air leakage, water infiltration and wind pressure



Reflections

For more information about **Simonton Windows®** and the **Reflections® 5500** series, contact your local Simonton representative or, visit **simonton.com** today.



Join the conversation



Corporate Headquarters:

3948 Townsfair Way, Suite 200, Columbus, Ohio 43219 | 1-800-SIMONTON (1-800-746-6686) | simonton.com

The information contained is current at the time of printing. Changes to the product(s) may have been made since publication. Not all features available on all products in all areas of the country. Some mullied configurations require multiple openings in the wall to comply with AAMA regulations in some states. Please consult your sales representative prior to purchasing. Due to the limitations of the printing process, actual colors may vary from printed materials. Please see a sample of the product before making your final selection. Simonton Windows®, Simonton®, We make lasting impressions®, Reflections®, Lap-Lok®, Simonton Sill®, ProSolar®, Decorum® and the stylized "S" are registered trademarks and Air Lok™ and Denny Clip™ are trademarks of Simonton Building Products, Inc. KeepSafe® is a registered trademark of Solutia Inc. Intercept® is a registered trademark of PPG Industries. Moen® is a registered trademark of Moen Incorporated. Master Lock® is a registered trademark of Master Lock Company LLC. Thermo-Tru® is a registered trademark of Thermo-Tru Corp.

Simonton windows and doors are tested to the advanced AAMA Gold Label Certification Program. The Gold Certification is AAMA's highest level of testing with windows and doors being tested for thermal performance as well as air, water and structural integrity. The standard AAMA silver label only requires thermal testing. Simonton's Product Development Center is an ATI-certified lab site that enables us to perform thorough, in-house structural and thermal testing. An AAMA gold label certifies that the units assembled on the production lines are using the same process and components as the unit that was tested. Only the AAMA Gold Label indicates that. The product underwent testing based on the stringent requirements of the ANSI/AAMA/NWWD101/1.S.2 and AAMA/WDMA/CSA 101/1.S.2/A440-05 industry standards. Certification to AAMA506/conforms to requirements of ASTM E 1886 & 1996. These tests were performed at an independent AAMA-accredited testing laboratory. An Independent (third-party) Validator through two unannounced plant inspections each year has continuously monitored the product production for compliance. ©2014 Simonton Building Products, Inc. Printed in U.S.A.